

i3368G Series
Pentium® M All-in-One
Mini ITX Board
with DualView display
User's Manual

Disclaimers

The information in this manual has been carefully checked and is believed to be accurate. IGoLogic, Inc. assumes no responsibility for any infringements of patents or other rights of third parties which may result from its use.

IGoLogic assumes no responsibility for any inaccuracies that may be contained in this document. IGoLogic makes no commitment to update or to keep current the information contained in this manual.

IGoLogic reserves the right to make improvements to this document and/or product at any time and without notice.

No part of this document may be reproduced, stored in a retrieval system, or transmitted, in any form or by any means, electronic, mechanical, photocopying, recording, or otherwise, without the prior written permission of IGoLogic, Inc.

CAUTION

Danger of explosion if battery is incorrectly replaced.

Replace only with the same or equivalent type

To be recommended by the manufacturer.

Dispose of used batteries according to the manufacturer's instructions

©Copyright 2006 by IGoLogic, Inc.

All rights reserved.

May 2006, Version A1

Printed in USA

ESD Precautions

Integrated circuits on computer boards are sensitive to static electricity. To avoid damaging chips from electrostatic discharge, observe the following precautions:

- Do not remove boards or integrated circuits from their anti-static packaging until you are ready to install them.
- Before handling a board or integrated circuit, touch an unpainted portion of the system unit chassis for a few seconds. This helps to discharge any static electricity on your body.
- Wear a wrist-grounding strap, available from most electronic component stores, when handling boards and components.

Trademarks Acknowledgments

IGOLOGIC is a trademark of IGoLogic, Inc.

MS-DOS and Windows '95 are trademarks of Microsoft Corporation.

AWARD is a trademark of Award Software. Inc.

IBM, PC/AT, PS/2, VGA are trademarks of International Business Machines Corporation.

Intel and Pentium are trademarks of Intel Corporation.

Winbond is a trademark of Winbond Electronics Corp.

SMI is a trademark of Silicon Motion Inc.

Other brand names and trademarks are the properties and registered brands of their respective owners.

This page does not contain any information.

Table of Contents

Disclaimers.....	ii
ESD Precautions.....	iii
Chapter 1.....	1
Introduction	1
1.1 Specifications	2
1.2 Utilities Supported.....	4
Chapter 2.....	5
Jumpers and Connectors	5
2.1 Board Layout and Fixing Holes	5
2.2 Placement.....	6
2.3 Jumper Settings.....	7
2.3.1 CMOS Clear Jumper.....	7
2.3.2 Compact Flash Power	7
2.3.3 LVDS Voltage Setting	8
2.3.4 COM1 & COM2 Setting.....	8
2.3.4 COM3 & COM4 Setting.....	8
2.4 Connectors	10
2.4.1 Enhanced IDE Interface Connector	11
2.4.2 VGA Connector.....	11
2.4.3 Parallel Port.....	12
2.4.4 Power Input Connector.....	13
2.4.5 Audio Connector	14
2.4.6 Keyboard and PS/2 Mouse Connectors	14
2.4.7 USB Connectors.....	15
2.4.8 Ethernet PJ-45 Connector	15
2.4.9 Serial Port Interface.....	16
2.4.10 Compact Flash Connector (Optional)	17
2.4.11 Connector for LVDS Flat Panel	18
2.4.12 LVDS Power Connector.....	19
2.4.13 Panel Connector	19

2.4.14	DIO Connector	19
Chapter 3	21
Hardware Description	21
3.1	Microprocessors	21
3.2	BIOS	21
3.3	System Memory	21
3.4	I/O Port Address Map	22
3.5	Interrupt Controller	23
Chapter 4	24
Award BIOS Utility	24
4.1	Entering Setup	24
4.2	Control Keys	25
4.3	Getting Help	25
4.4	The Main Menu	26
4.5	Standard CMOS Setup Menu	27
4.6	Advanced BIOS Features	31
4.7	Advanced Chipset Features	36
4.8	Integrated Peripherals	38
4.9	Power Management Setup	43
4.10	PnP/PCI Configuration Setup	48
4.11	PC Health Status	51
4.12	Frequency/Voltage Control	52
4.13	Load Fail-Safe Defaults	53
4.14	Load Optimized Defaults	54
4.15	Set Supervisor/User Password	55
4.16	Save & Exit Setup	56
4.17	Exit Without Saving	57
Appendix A	59
Watch Dog Timer	59
Watchdog Timer Setting	59

Chapter 1

Introduction

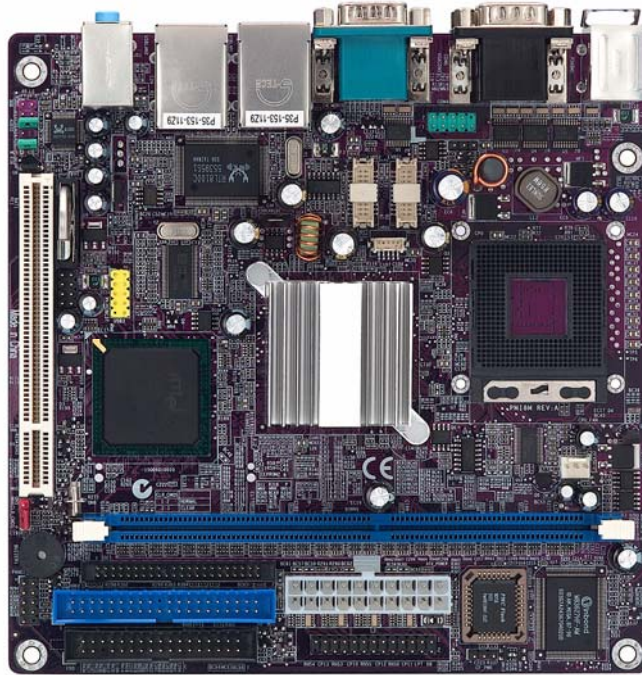

The **I3368G** is an Intel® Pentium® M/Celeron® M CPU equipped Mini ITX board with graphics, Fast Ethernet and audio interface. Designed with the space-limited applications in mind, the **I3368G** is practically the finest embedded Pentium® M board that exists. **I3368G Series** adapt an Intel® low power consumption Pentium® M microprocessors. To simplify system integration, it packs provisions such as super I/Os, UXGA, LCD, Ethernet, solid state disk, all on a single board. Unique embedded features such as 4 serial ports (4 x RS-232) Mini ITX ability and that allow adoption of an extensive array of PC peripherals. The industrial-grade construction of **I3368G series** allows your system to endure the continuous operation in hostile environments where stability and reliability are basic

requirements. System dependability of **I3368G series** are enhanced by its built-in watchdog timer, a special industrial feature not commonly seen on other motherboards.

Designed for the professional embedded developers, the Pentium® M embedded board **I3368G Series** is virtually the ultimate one-step solution for embedded system applications.

1.1 Specifications

- **CPU:** Intel Pentium-M and Celeron Processors System
Socket Type: Socket-479
- **Chipset:** Intel® 852GM + ICH*4
- **Bus Clock:** 400MHz
- **BIOS:**
 - Phoenix-Award BIOS, Y2K compliant
 - 4Mbit Flash, DMI, Plug and Play
 - SmartView for multiple LCD type selection, display mode option and application extension features
 - RPL/PXE Ethernet Boot ROM
 - "Load Optimized Default" to backup customized Setting in the BIOS flash chip to prevent from CMOS battery fail
- **System Memory:**
 - One 184-Pin DDR SDRAM DIMM.
 - Maximum DDR of up to 1GB DDR266
- **L2 Cache:** integrated in CPU
- **Onboard IDE:**
 - 2 parallel ATA-100 as 1* 44-pin 2.0 pitch box-header and 1*40-pin 2.0 pitch box-header.
 - PATA-100 as PIO Mode 0-4, DMA Mode 0-2 and Ultra DMA/33/66/100
- **Compact Flash Socket:**
 - One Compact Flash Type II Socket(Optional)
- **Onboard Multi I/O:**

- One floppy port
- 4 x RS-232
- **USB Interface:** 6 USB ports with fuse protection and complies with USB Spec. Rev. 2.0
- **Real Time Clock:** Integrate Intel® ICH*4
- **Watchdog Timer:**
 - 1~255 seconds; up to 255 levels
- **Graphics/Streaming:**
 - Integrate Intel® 852GM GMCH
 - Unified Memory Architecture shares system memory up to 32MB
 - Single display mode maximum resolutions:
 - ◆ CRT: 1600 x1200 @ 60Hz
 - ◆ LVDS LCD: 1400 x 1050
 - DualView display mode:
 - ◆ CRT: 1600 x1200 @60 Hz
 - ◆ LVDS LCD: 1400 x 1050
 - LCD backlight control supported
- **Ethernet:**
 - Realtek 8100C PCI Bus 10/100M Base-T
 - Wake On LAN (via ATX power supply)
 - Equipped with RJ-45 interface
 - Optional with Realtek RTL8110S for 10/100/1000Base-T
- **Audio:**
 - Realtek AC'97 codec audio
 - MIC-in, Line-in, Line-out
- **Power Management:** ACPI (Advanced Configuration and Power Interface)

- **Form Factor:** Mini ITX form factor
- **Size:** 170mm* 170mm

NOTE: *Specifications are subject to change without notice.*

1.2 Utilities Supported

- Chipset Driver
- Ethernet Driver
- VGA Drivers
- Audio Drivers

Chapter 2 Jumpers and Connectors

2.1 Board Layout and Fixing Holes

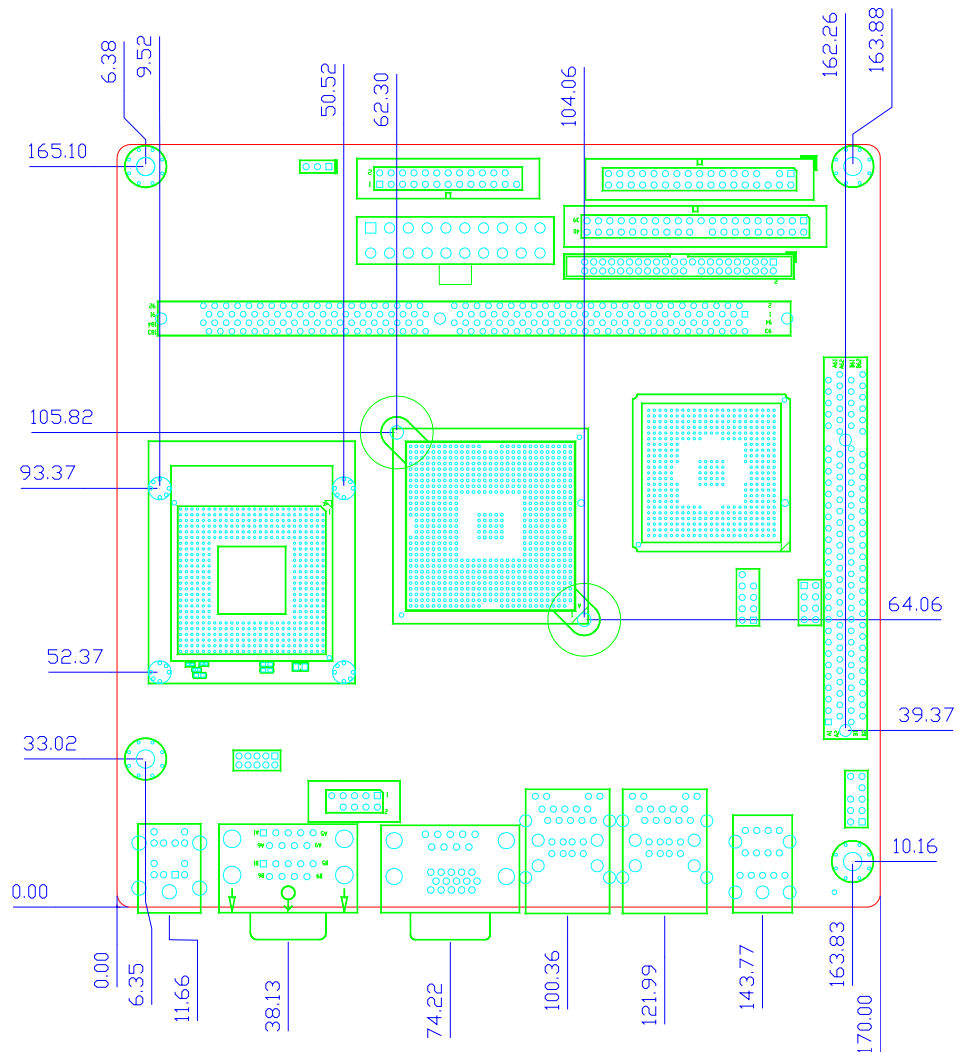

2.2 Placement

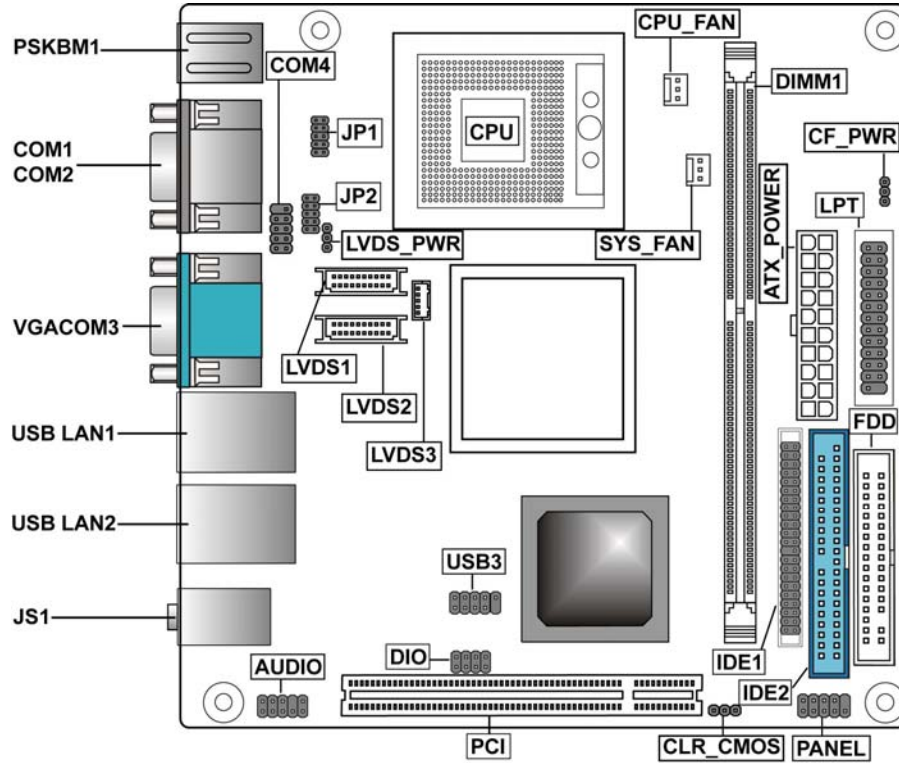

2.3 Jumper Settings

The **I3368G Series** is configured to match the needs of your application with the proper jumper settings. The table below is a summary of all the jumpers and their corresponding functions onboard the **I3368G Series**. The succeeding tables show the correct jumper settings for the onboard devices.

I3368G Jumper setting :

Jumper	Connector Type	Description	Default
CLR_CMOS	Header 3*1	CLEAR CMOS	Short 1-2: Normal
CF_PWR	Header 3*1	CF power voltage	Short 1-2: VCC3.3
LVDS_PWR	Header 3*1	LVDS power voltage	Short 1-2: VCC3.3
JP1	Header 5*2	COM1/COM2 Selection	Short 7-9,8-10: Normal
JP2	Header 5*2	COM1/COM2 Selection	Short7-9,8-10:Normal

2.3.1 CMOS Clear Jumper

Options	Settings
Normal	Short 1-2 (default)
Clear CMOS	Short 2-3

CLR_CMOS

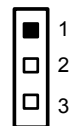

2.3.2 Compact Flash Power

Options	Settings
3.3V	Short 1-2(default)
5V	Short 2-3

CF_PWR



2.3.3 LVDS Voltage Setting

VDDM	Settings
5V	Short 2-3
3.3V	Short 1-2(default)

LVDS_PWR

1 2 3

2.3.4 COM1 & COM2 Setting

Option	COM1 Pin9	COM2 Pin9	JP1
Short 1-3		+5V	
Short 3-5		+12V	
Short 7-9		RI	
Short 2-4	+5V		
Short 4-6	+12V		
Short 8-10	RI		

2.3.5 COM3 & COM4 Setting

Option	COM3 Pin9	COM4 Pin9	JP2
Short 1-3	+5V		
Short 3-5	+12V		
Short 7-9	RI		
Short 2-4		+5V	
Short 4-6		+12V	

Short 8-10		RI	
------------	--	----	--

2.4 Connectors

The connectors allow the CPU card to connect with other parts of the system. Some problems encountered by your system may be a result from loose or improper connections. Ensure that all connectors are in place and firmly attached. The following table lists the function of each connector on the **I3368G Series**. Their

Name	Connector type	Description
DIMM1	DDR DIMM	2.5V un-Buffered 184 pin socket
IDE2	Header 20*2 profile	Secondary IDE CONN. (blue)
IDE1	Header 22*2 profile	Primary IDE CONN.
USBLAN1	USB-DUAL/RJ45-T	USB Dual Port + LAN CONN
USBLAN2	USB-DUAL/RJ45-T	USB Dual Port + LAN CONN
PSKBM1	Mini din connector	PS/2 Keyboard & Mouse
COM1/COM2	D-Type*2 connector	Serial port*2
VGA/COM3	D-Type*2 connector	VGA port*1+Serial port*1
COM4	Header 5*2 Low Profile	Header for Series port with cable
LPT	LPT header	Parallel port
CPU_FAN, SYS_FAN	Header 1*3 profile	CPU fan and System fan
ATX_POWER	ATX 10*2connecto	ATX power supply CONN.
USB3	Header 5*2	USB Header
AUDIO	Header 5*2	Audio connector
PANEL	Header 5*2	Dual-color MSG LED, HDD LED, Power switch, and H/W reset
DIO	Header 4*2	DIO Connector

corresponding pin assignments are described in Chapter 3.

2.4.1 Enhanced IDE Interface Connector

The **I3368G** includes a PCI bus enhanced IDE controller that can support master/slave mode and post write transaction mechanisms with 64-byte buffer and master data transaction.

44-pin IDE Interface Connector:

Pin	Description	Pin	Description	Pin	Description
1	Reset #	2	GND	3	Data 7
4	Data 8	5	Data 6	6	Data 9
7	Data 5	8	Data 10	9	Data 4
10	Data 11	11	Data 3	12	Data 12
13	Data 2	14	Data 13	15	Data 1
16	Data 14	17	Data 0	18	Data 15
19	GND	20	No connector	21	No connector
22	GND	23	IOW #	24	GND
25	IOR #	26	GND	27	IOCHRDY
28	No connector	29	No connector	30	GND-Default
31	Interrupt	32	No connector	33	SA1
34	No connector	35	SA0	36	SA2
37	HDC CS0 #	38	HDC CSI #	39	HDD Active #
40	GND	41	VCC	42	VCC
43	GND	44	N.C		

2.4.2 VGA Connector

The **I3368G** has three connectors that support CRT VGA and flat panel displays, individually or simultaneously. **VGA** is a slim type 15-pin D-Sub connector commonly used for the CRT VGA display, Configuration of the VGA interface is done via the software utility and no jumper setting is required. The following two tables are the pin assignments for the CRT/VGA connector and the flat panel connector.

VGA: CRT/VGA Connector Pin Assignment

Pin	Description	Pin	Description	Pin	Description
1	Red	2	Green	3	Blue
4	N/A	5	GND	6	AGND
7	AGND	8	AGND	9	N/A
10	GND	11	N/A	12	DDC DAT
13	Horizontal Sync	14	Vertical Sync	15	DDC CLK

2.4.3 Parallel Port

The **I3368G** has a multi-mode parallel port to support:

- **Standard mode:**
IBM PC/XT, PC/AT and PS/2™ compatible with bi-directional parallel port
- **Enhanced mode:**
Enhance parallel port (EPP) compatible with EPP 1.7 and EPP 1.9 (IEEE 1284 compliant)
- **High speed mode:**
Microsoft and Hewlett Packard extended Mini ITXabilities port (ECP) IEEE 1284 compliant

The address select of the onboard parallel port in LPT1 (3BCH) or disabled is done by BIOS CMOS setup.

Pin	Description	Pin	Description
1	Strobe#	2	Auto Form Feed#
3	Data 0	4	Error#
5	Data 1	6	Initialize#
7	Data 2	8	Printer Select In#
9	Data 3	10	GND
11	Data 4	12	GND
13	Data 5	14	GND
15	Data 6	16	GND
17	Data 7	18	GND
19	Acknowledge#	20	GND
21	Busy	22	GND
23	Paper Empty#	24	GND
25	Printer Select	26	NC

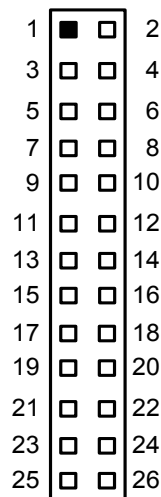

2.4.4 Power Input Connector

The following table is the pin assignment for the standard power supply.

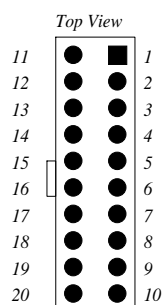

Pin	Signals	Description	Pin	Signals	Description
1	VCC3	Power : 3.3V	11	VCC3	Power : 3.3V
2	VCC3	Power : 3.3V	12	-12V	Power : -12V
3	GND	System Ground	13	GND	System Ground
4	VCC	Power : +5V	14	PS-ON#	Power_on Signal
5	GND	System Ground	15	GND	System Ground
6	VCC	Power : +5V	16	GND	System Ground
7	GND	System Ground	17	GND	System Ground
8	PWROK	Power Good Signal	18	-5V	Power : -5V
9	5VSB	Standby Power : +5V	19	VCC	Power : +5V
10	+12V	Power : +12V	20	VCC	Power : +5V

2.4.5 Audio Connector

The **I3368G** supports audio interface.

AUDIO		Pin	Signal Name	Pin	Signal Name
1	■ □	1	AUD_MIC	2	AUD_GND
3	□ □	3	MIC_BIAS	4	AUD_VCC
5	□ □	5	AUD_F_R	6	AUD_RET_R
7	□ □	7	REVD	8	KEY
9	□ □	9	AUD_F_L	10	AUD_RET_L

2.4.6 Keyboard and PS/2 Mouse Connectors

The **I3368G** provides a keyboard and Mouse interface that is a DIN connector .

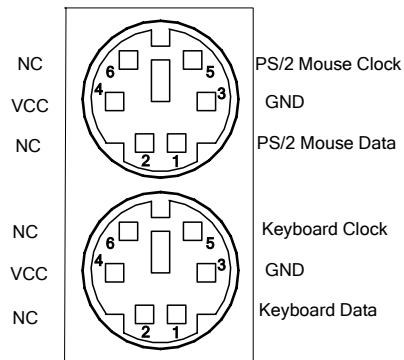

2.4.7 USB Connectors

The **I3368G Series** features four Universal Serial Bus (USB) connectors as USB 2.0 compliant (480Mbps) that can adapt any USB peripherals, such as monitor, keyboard and mouse etc. The **I3368G Series** has a box-header connectors and two USB connectors.

USB Connector Pin Assignment

Pin	Description	Pin	Description
1	VCC	2	VCC
3	D0-	4	D1-
5	D0+	6	D1+
7	Ground (GND)	8	Ground (GND)
9	NC	10	Ground (GND)

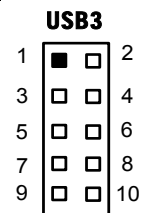

USB Connector Pin Assignment

Pin	Signal Name
1	USB Vcc
2	USB -
3	USB +
4	USB GND

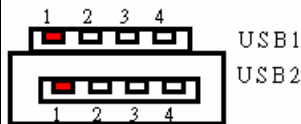

2.4.8 Ethernet PJ-45 Connector

The RJ-45 connector is used for Ethernet. To connect the **I3368G** to a 100/10 Base-T hub, just plug one end of the cable into the connect the other end of the cable to a 1000/100/10-Base-T hub.

2.4.8.1 Pin Assignment

RJ-45 Connector Pin Assignment

Pin	Signal
1	Tx+(Data transmission positive)
2	Tx-(Data transmission negative)
3	Rx+(Data reception positive)
4	RJ45 termination
5	RJ45 termination
6	Rx- (Data reception negative)
7	RJ45 termination
8	RJ45 termination

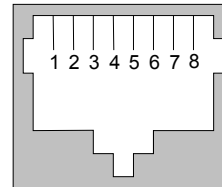

RJ-45

2.4.9 Serial Port Interface

The **I3368G Series** has four onboard serial ports, **COM1**, **COM2**, **COM3**, **COM4** are RS-232 Port Connector

The connector, COM 1,COM2,COM3 are DB-9 connector, and the following table shows the pin assignments of this connector.

Pin	Signal Name
1	DCD, Data carrier detect
2	RXD, Receive data
3	TXD, Transmit data
4	DTR, Data terminal ready
5	GND, ground
6	DSR, Data set ready
7	RTS, Request to send
8	CTS, Clear to send
9	RI/+5V/+12V Ring indicator

COM1/COM2/COM3

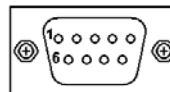

2.4.9.1 COM4 Port Connectors

The RS-232 pin assignments are listed on the following table.

Pin	Description	Pin	Description
1	Data Carrier Detect (DCD)	2	Receive Data (RXD)
3	Transmit Data (TXD)	4	Data Terminal Ready (DTR)
5	GND	6	Data Set Ready (DSR)
7	Request to Send (RTS)	8	Clear to Send (CTS)
9	Ring/+5V/+12V Indicator (RI)	10	NC

COM4

2.4.10 Compact Flash Connector (Optional)

The I3368G Series is equipped with a CompactFlash disk socket on the solder side and it supports the IDE2 interface CompactFlash disk card. The socket itself is specially designed to prevent any incorrect installation of the CompactFlash disk card.

When installing or removing the CompactFlash disk card, make sure the system power is off.

The CompactFlash disk card is defaulted as the E: or F: disk drive in the PC system.

2.4.11 Connector for LVDS Flat Panel

LVDS1(CH A)

Pin	Deception	Pin	Deception
1	VCCM	2	VCCM
3	VCCM	4	VCCM
5	DA0-	6	DA3-
7	DA0+	8	DA3+
9	GND	10	GND
11	DA1-	12	CLKA-
13	DA1+	14	CLKA+
15	GND	16	GND
17	DA2-	18	GND
19	DA2+	20	GND

LVDS2(CH B)

Pin	Deception	Pin	Deception
1	VCCM	2	VCCM
3	VCCM	4	VCCM
5	DB0-	6	DB3-
7	DB0+	8	DB3+
9	GND	10	GND
11	DB1-	12	CLKB-
13	DB1+	14	CLKB+
15	GND	16	GND
17	DB2-	18	GND
19	DB2+	20	GND

2.4.12 LVDS Power Connector

LVDS power connector is a Hirose DF13-5P- 1.25V(50) connector, the match side connector is DF13-5S-1.25C

Pin	Signal
1	+12VM1
2	VCC (+5V)
3	+12VM1
4	ENABLE
5	GND

LVDS3

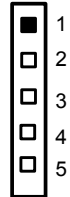

2.4.13 Panel Connector

Pin	Description	Pin	Description
1	HD LED+	2	MSG LED+
3	HD LED-	4	MSG LED-
5	Reset SW-	6	PWR SW+
7	Reset SW+	8	PWR SW-
9	NC	10	NC

PANEL

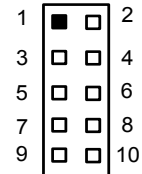

2.4.14 DIO Connector

Pin	Description	Pin	Description
1	DI0	2	DO0
3	DI1	4	DO1
5	DI2	6	DO2
7	GND	8	GND

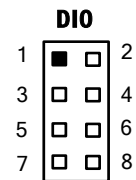

	I/O address
digital I/O input bit0	(40B8H bit0)
digital I/O input bit1	(40B8H bit1)
digital I/O input bit2	(40B8H bit2)
digital I/O output bit0	(40B8H bit4)
digital I/O output bit1	(40B8H bit5)
digital I/O output bit2	(40B8H bit6)

Chapter 3

Hardware Description

3.1 Microprocessors

The **I3368G Series** supports Intel® Celeron® M and Pentium® M CPUs. Systems based on these CPUs can be operated under Windows 2000/XP and Linux environments. The system performance depends on the microprocessor installed onboard. Make sure all settings are correct for the installed microprocessor to prevent any damage to the CPU.

3.2 BIOS

System BIOS used on the **I3368G Series** is Phoenix-Award Plug and Play BIOS. The **I3368G Series** contains a single 4Mbit Flash.

3.3 System Memory

The **I3368G Series** industrial CPU card supports one 184-pin DDR socket for a maximum memory of 1GB DDR SDRAMs. The memory module can come in sizes of 64MB, 128MB, 256MB, 512MB and 1GB.

3.4 I/O Port Address Map

The Intel® Pentium® M/Celeron® M CPU communicates via I/O ports. It has a total of 1KB port addresses available for assignment to other devices via I/O expansion cards.

Address	Devices
000-01F	DMA controller #1
020-03F	Interrupt controller #1
040-05F	Timer
060-06F	Keyboard controller
070-07F	Real time clock, NMI
080-09F	DMA page register
0A0-0BF	Interrupt controller #2
0C0-0DF	DMA controller #2
0F0	Clear math coprocessor busy signal
0F1	Reset math coprocessor
0F8-0FF	Math processor
1F0-1F8	Fixed disk controller
250-25F	HR I/O
300-31F	Prototype card
380-38F	SDLC #2
3A0-3AF	SDLC #1
3B0-3BF	MDA video card (including LPT1)
3C0-3CF	EGA card
3D0-3DF	CGA card
3F0-3F7	Floppy disk controller
3F8-3FF	Serial port #1 (COM1)
3E8-3EF	Serial port #3 (COM3)
2F8-2FF	Serial port #2 (COM2)
2E8-2EF	Serial port #4 (COM4)
3F0-3FF	Super I/O

3.5 Interrupt Controller

The **I3368G Series** is a 100% PC compatible control board. It consists of 16 interrupt request lines. Four out of the sixteen can either be programmable. The mapping list of the 16 interrupt request lines is shown on the following table.

NMI	Parity check error
IRQ0	System timer output
IRQ1	Keyboard
IRQ2	Interrupt rerouting from IRQ8 through IRQ15
IRQ3	Serial port #2
IRQ4	Serial port #1
IRQ5	Reserved
IRQ6	Floppy disk controller
IRQ7	Parallel port #1
IRQ8	Real time clock
IRQ9	Reserved
IRQ10	Serial port #3
IRQ11	Serial port #4
IRQ12	PS/2 Mouse
IRQ13	Math coprocessor
IRQ14	Primary IDE channel
IRQ15	Secondary IDE Channel

Chapter 4

Award BIOS Utility

The Phoenix-Award BIOS has a built-in Setup program that allows users to modify the basic system configuration. This type of information is stored in a battery-backed RAM (CMOS RAM) that retains the Setup information each time the power is turned off.

4.1 Entering Setup

There are two ways to enter the Setup program. You may either turn ON the computer and press immediately, or press the and/or <Ctrl>, <Alt>, and <Esc> keys simultaneously when the following message appears at the bottom of the screen during POST (Power on Self Test).

TO ENTER SETUP PRESS DEL KEY

If the message disappears before you respond and you still wish to enter Setup, restart the system and try again. This is possible by turning the system power to OFF then to ON, pressing the "RESET" button on the system case, or by simultaneously pressing <Ctrl>, <Alt>, and keys. If you do not press the keys at the correct time and the system does not boot, an error message will be displayed and you will be prompted with the following:

PRESS <F1> TO CONTINUE, <CTRL-ALT-ESC> OR TO ENTER
SETUP

4.2 Control Keys

Up arrow	Moves cursor to the previous item
Down arrow	Moves cursor to the next item
Left arrow	Moves cursor to the item on the left hand
Right arrow	Move to the item in the right hand
Esc key	Main Menu -- Quits and deletes changes into CMOS Status Page Setup Menu and Option Page Setup Menu -- Exits current page and returns to Main Menu
PgUp/"+" key	Increases the numeric value or makes changes
PgDn/"-" key	Decreases the numeric value or makes changes
F1 key	General help, only for Status Page Setup Menu and Option Page Setup Menu
(Shift) F2 key	Change color from total 16 colors. F2 to select color forward, (Shift) F2 to select color backward
F3 key	Reserved
F4 key	Reserved
F5 key	Restores the previous CMOS value from CMOS, only for Option Page Setup Menu
F6 key	Loads the default CMOS value from BIOS default table, only for Option Page Setup Menu
F7 key	Loads the Setup default, only for Option Page Setup Menu
F8 key	Reserved
F9 key	Reserved
F10 key	Saves all the CMOS changes, only for Main Menu

4.3 Getting Help

- **Main Menu**
The on-line description of the highlighted setup function is displayed at the bottom of the screen.
- **Status Page Setup Menu/Option Page Setup Menu**
Press <F1> to pop up a small help window that describes the appropriate keys to use and the possible selections for the highlighted item. To exit the Help Window press <F1> or <Esc>.

4.4 The Main Menu

Once you enter the Award BIOS CMOS Setup Utility, the Main Menu will appear on the screen. The Main Menu allows you to select from ten setup functions and two exit choices. Use the arrow keys to select the setup function you intend to configure then press <Enter> to accept or enter its sub-menu.

CMOS Setup Utility-Copyright © 2000-2004 Award Software

▶ Standard CMOS Features	▶ Frequency/Voltage Control
▶ Advanced BIOS Features	Load Fail-Safe Defaults
▶ Advanced Chipset Features	Load Optimized Defaults
▶ Integrated Peripherals	Set Supervisor Password
▶ Power Management Setup	Set User Password
▶ PnP/PCI Configurations	Save & Exit Setup
	Exit Without Saving
Esc : Quit F9: Menu in BIOS ↑ ↓ → ← : Select Item	
F10 : Save & Exit Setup	
F6 : SAVE CMOS TO BIOS F7: LOAD CMOS FROM BIOS	
Time, Date, Hard Disk Type...	

NOTE: *If you find that your computer cannot boot after making and saving system changes with Setup, the Award BIOS, via its built-in override feature, resets your system to the CMOS default settings.*

We strongly recommend that you avoid making any changes to the chipset defaults. These defaults have been carefully chosen by both Award and your system manufacturer to provide the absolute maximum performance and reliability.

4.5 Standard CMOS Setup Menu

The items in Standard CMOS Setup Menu are divided into 10 categories. Each category includes no, one or more than one setup items. Use the arrow keys to highlight the item and then use the <PgUp> or <PgDn> keys to select the value you want in each item.

**CMOS Setup Utility-Copyright © 2000-2004 Award Software
Standard CMOS Features**

Date (mm:dd:yy)	Thu, Jan 10 2002	Item Help
Time (hh:mm:ss)	2 : 31 : 24	Menu Level ▶
▶ IDE Primary Master		Change the Day, month, Year and Century
▶ IDE Primary Slave		
▶ IDE Secondary Master		
▶ IDE Secondary Slave		
Drive A	1.44M, 3.5 in.	
Drive B	None	
Video	EGA/VGA	
Halt On	All, But Keyboard	
↑↓→← : Move Enter: Select +/-/PU/PD: Value F10: Save ESC: Exit F1: General Help F5: Previous Values F6: Fail-Safe Defaults F7: Optimized Defaults		

- **Date**

The date format is <day>, <date> <month> <year>. Press <F3> to show the calendar.

day	The day of week, from Sun to Sat, determined by the BIOS, is read only
date	The date, from 1 to 31 (or the maximum allowed in the month), can key in the numerical / function key
month	The month, Jan through Dec.
year	The year, depends on the year of BIOS

- **Time**

The time format is <hour> <minute> <second> accepting either functions key or numerical key. The time is calculated based on the 24-hour military-time clock. For example, 1 p.m. is 13:00:00.

- **Primary Master/Primary Slave/Secondary Master/Secondary Slave**

The categories identify the types of one channel that have been installed in the computer. There are 45 predefined types and 2 users definable types are for Enhanced IDE BIOS. Type 1 to Type 45 is predefined. Type User is user-definable.

Press <PgUp>/<+> or <PgDn>/<-> to select a numbered hard disk type or type the number and press <Enter>. Note that the specifications of your drive must match with the drive table. The hard disk will not work properly if you enter improper information within this category. If your hard disk drive type does not match or is not listed, you can use Type User to define your own drive type manually.

If you select Type User, related information is asked to be entered to the following items. Enter the information directly from the keyboard and press <Enter>. This information should be provided in the documentation from your hard disk vendor or the system manufacturer.

If the controller of HDD interface is ESDI, select "Type 1".

If the controller of HDD interface is SCSI, select "None".

If the controller of HDD interface is CD-ROM, select "None".

CYLS.	number of cylinders	LANDZONE	landing zone
HEADS	number of heads	SECTORS	number of sectors
PRECOMP	write precom	MODE	HDD access mode

If there is no hard disk drive installed, select NONE and press <Enter>.

- **Drive A type/Drive B type**

The category identifies the types of floppy disk drive A or drive B installed in the computer.

None	No floppy drive installed
360K, 3.5 in	3.5 inch PC-type standard drive; 360Kb Mini ITXcity
1.2M, 3.5 in	3.5 inch AT-type high-density drive; 1.2MB Mini ITXcity
720K, 3.5 in	3.5 inch double-sided drive; 720Kb Mini ITXcity
1.44M, 3.5 in	3.5 inch double-sided drive; 1.44MB Mini ITXcity
2.88M, 3.5 in	3.5 inch double-sided drive; 2.88MB Mini ITXcity

● **Halt On**

This field determines whether the system will halt if an error is detected during power up.

No errors	The system boot will halt on any error detected. (default)
All errors	Whenever the BIOS detect a non-fatal error, the system will stop and you will be prompted.
All, But Keyboard	The system boot will not stop for a keyboard error; it will stop for all other errors.
All, But Diskette	The system boot will not stop for a disk error; it will stop for all other errors.
All, But Disk/Key	The system boot will not stop for a keyboard or disk error; it will stop for all other errors.

4.6 Advanced BIOS Features

This section allows you to configure and improve your system and allows you to set up some system features according to your preference.

CMOS Setup Utility-Copyright © 2000-2004 Award Software Advanced BIOS Features

CPU Feature	Press Enter	Item Help
Hard Disk Boot Priority	Press Enter	
Virus Warning	Disabled	Menu Level ►
CPU L1 & L2 Cache	Enabled	
CPU L2 Cache	Enabled	
Quick Power On Self Test	Enabled	
First Boot Device	HDD-0	
Second Boot Device	Floppy	
Third Boot Device	SCSI	
Boot Other Device	Enabled	
Swap Floppy Drive	Disabled	
Boot Up Floppy Seek	Enabled	
Boot Up NumLock Status	On	
Gate A20 Option	Fast	
Typematic Rate Setting	Disabled	
Typematic Rate (Chars/Sec)	6	
Typematic Delay (Msec)	250	
Security Option	Setup	
APIC Mode	Enabled	
PS/2 Mouse Function Control	Enabled	
OS Select for DRAM >64MB	Non-OS2	
Report No FDD For WIN 95	No	
Full Screen Logo Show	Disabled	
Small Screen Show	Disabled	
Summary Screen Show	Enabled	
Display board ID	Disabled	
↑↓→← : Move Enter: Select +/-/PU/PD: Value F10: Save ESC: Exit F1: General Help F5: Previous Values F6: Fail-Safe Defaults F7: Optimized Defaults		

- **Hard Disk Boot Priority**

This item can select boot device priority.

- **Virus Warning**

This option flashes on the screen. During and after the system boot up, any attempt to write to the boot sector or partition table of the hard disk drive will halt the system with the following message. You can run an anti-virus program to locate the problem. The default setting is “*Disabled*”.

! WARNING ! <i>Disk boot sector is to be modified</i> Type “Y” to accept write or “N” to abort write Award Software, Inc.

Enabled	Activates automatically when the system boots up causing a warning message to appear when there is an attempt to access the boot sector or hard disk partition table.
Disabled	No warning message will appear when attempts to access the boot sector or hard disk partition table are made.

NOTE: *This function is only available with DOS and other operating systems that do not trap INT13.*

- **CPU L1 & L2 Cache**

These two options speed up memory access. However, it depends on the CPU/chipset design. The default setting is “*Enabled*”. CPUs with no built-in internal cache will not provide the “CPU Internal Cache” item on the menu.

Enabled	Enable cache
Disabled	Disable cache

- **Quick Power On Self Test**

This option speeds up Power on Self Test (POST) after you turn on the system power. If set as Enabled, BIOS will shorten or skip some check items during POST. The default setting is “*Enabled*”.

Enabled	Enable Quick POST
Disabled	Normal POST

-

- **First/Second/Third Boot Device**
These items allow the selection of the 1st, 2nd, and 3rd devices that the system will search for during its boot-up sequence. The wide range of selection includes Floppy, LS120, ZIP100, HDD0~3, SCSI, and CDROM.
- **Boot Other Device**
This item allows the user to enable/disable the boot device not listed on the First/Second/Third boot devices option above. The default setting is **Enabled**.
- **Swap Floppy Drive**
This allows you to determine whether to enable Swap Floppy Drive or not. When enabled, the BIOS swap floppy drive assignments so that Drive A becomes Drive B, and Drive B become Drive A. By default, this field is set to *Disabled*.
- **Boot Up Floppy Seek**
During POST, BIOS will determine the floppy disk drive type, 40 or 80 tracks, installed in the system. 360Kb type is 40 tracks while 720Kb, 1.2MB and 1.44MB are all 80 tracks. The default value is “*Enabled*”.

Enabled	BIOS searches for floppy disk drive to determine if it is 40 or 80 tracks. Note that BIOS can not tell from 720K, 1.2M or 1.44M drives type as they are all 80 tracks.
Disabled	BIOS will not search for the type of floppy disk drive by track number. There will be no warning message displayed if the drive installed is 360K.

- **Boot Up NumLock Status**
This option enables and disables the number lock function of the keypad. The default value is “*On*”.

On	Keypad functions confine with numbers
Off	Keypad functions convert to special functions (i.e., left/right arrow keys)

-

- **Gate A20 Option**

The default value is “Fast”.

Normal	The A20 signal is controlled by keyboard controller or chipset hardware.
Fast	Default: Fast. The A20 signal is controlled by Port 92 or chipset specific method.

- **Typematic Rate Setting**

This determines the typematic rate of the keyboard. The default value is “Disabled”.

Enabled	Enable typematic rate and typematic delay programming
Disabled	Disable typematic rate and typematic delay programming. The system BIOS will use default value of these 2 items and the default is controlled by keyboard.

- **Typematic Rate (Chars/Sec)**

This option refers to the number of characters the keyboard can type per second. The default value is “6”.

6	6 characters per second
8	8 characters per second
10	10 characters per second
12	12 characters per second
15	15 characters per second
20	20 characters per second
24	24 characters per second
30	30 characters per second

- **Typematic Delay (Msec)**

This option sets the display time interval from the first to the second character when holding a key. The default value is “250”.

250	250 msec
500	500 msec
750	750 msec
1000	1000 msec

- **Security Option**

This item allows you to limit access to the system and Setup, or just to Setup. The default value is "Setup".

System	The system will not boot and access to Setup will be denied if the incorrect password is entered at the prompt.
Setup	The system will boot, but access to Setup will be denied if the correct password is not entered at the prompt.

NOTE: *To disable security, select PASSWORD SETTING at Main Menu and then you will be asked to enter password. Do not type anything, just press <Enter> and it will disable security. Once the security is disabled, the system will boot and you can enter Setup freely.*

- **OS Select for DRAM >64MB**

This segment is specifically created for OS/2 when DRAM is larger than 64MB. If your operating system is OS/2 and DRAM used is larger than 64MB, you have to select "OS 2", otherwise (under non-OS2), default is NON-OS2. The default value is "Non-OS2".

- **Report No FDD For Win 95**

This option allows Windows 95 to share IRQ6 (assigned to a floppy disk drive) with other peripherals in case the drive does not exist. The default setting is "No".

4.7 Advanced Chipset Features

Since the features in this section are related to the chipset on the CPU board and are completely optimized, you are not recommended to change the default settings in this setup table unless you are well oriented with the chipset features.

**CMOS Setup Utility-Copyright © 1984-2001 Award Software
Advanced Chipset Features**

		Item Help
DRAM Timing	By SPD	
CASs Latency Time	2.5	
Active to Recharge Delay	7	Menu Level ►
DRAM RAS# to CAS# Delay	3	
DRAM RAS# Recharge	3	
DRAM Data Integrity Mode	Non-ECC	
MGM Core Frequency	Auto Max 400/333MHz	
System BIOS Cacheable	Enable	
Video BIOS Cacheable	Disabled	
Memory Hole At 15M-16M	Disabled	
Delayed Transaction	Disabled	
Delay Prior to Thermal	16 Min	
AGP Aperture Size (MB)	64	
Init Display First	Onboard	
** On-Chip VGA Setting **		
On-Chip VGA	Enabled	
On-Chip Frame Buffer Size	32MB	
Boot Display	Auto	
Panel Scaling	Auto	
Panel Number	640 x480	
↑↓→← : Move Enter: Select +/-/PU/PD: Value F10: Save ESC: Exit F1: General Help F5: Previous Values F6: Fail-Safe Defaults F7: Optimized Defaults		

- **SDRAM CAS latency Time**

You can select CAS latency time in HCLKs 2, 3, or Auto. The board designer should set the values in this field, depending on the DRAM installed. Do not change the values in this field unless you change specifications of the installed DRAM or the installed CPU.

- **DRAM Data Integrity Mode**
This option sets the data integrity mode of the DRAM installed in the system. The default setting is “*Non-ECC*”.
- **System BIOS Cacheable**
Selecting Enabled allows caching of the system BIOS ROM at F0000h-FFFFFh, resulting in better system performance. However, if any program writes to this memory area, a system error may result. The default value is “*Disabled*”.
- **Video BIOS Cacheable**
This item allows you to change the Video BIOS location from ROM to RAM. Video Shadow will increase the video speed.
- **Video RAM Cacheable**
Selecting Enabled allows caching of the video BIOS ROM at C0000h to C7FFFh, resulting in better video performance. However, if any program writes to this memory area, a system error may result. The default value is “*Disabled*”.
- **Memory Hole at 15M-16M**
You can reserve this area of system memory for ISA adapter ROM. When this area is reserved, it cannot be cached. The user information of peripherals that need to use this area of system memory usually discusses their memory requirements. The default value is “*Disabled*”.
- **Delayed Transaction**
The chipset has an embedded 32-bit posted write buffer to support delay transactions cycles. Select *Enabled* to support compliance with PCI specification version 2.1. The options available are *Enabled* and *Disabled*.
- **AGP Aperture Size (MB)**
The field sets aperture size of the graphics. The aperture is a portion of the PCI memory address range dedicated for graphics memory address space. Host cycles that hit the aperture range are forwarded to the AGP without any translation. The options available are 4M, 8M, 16M, 32M, 64M, 128M and 256M.

4.8 Integrated Peripherals

This option sets your hard disk configuration, mode and port.

CMOS Setup Utility-Copyright © 1984-2001 Award Software Integrated Peripherals

▶ On Chip IDE Device	Press Enter	
▶ On Board Device	Press Enter	Menu Level ▶
▶ Superior Device	Press Enter	
Onboard LAN boot ROM	Disable	
↑↓→← : Move Enter: Select +/-/PU/PD: Value F10: Save ESC: Exit F1: General Help F5: Previous Values F6: Fail-Safe Defaults F7: Optimized Defaults		

CMOS Setup Utility-Copyright © 1984-2001 Award Software On Chip IDE Device

IDE DMA transfer Access	Enabled	
On-Chip Primary PCI IDE	Enabled	Menu Level ▶
IDE Primary Master PIO	Auto	
IDE Primary Master PIO	Auto	
IDE Primary Master UDMA	Auto	
IDE Primary Master UDMA	Auto	
On-Chip Primary PCI IDE	Enabled	
IDE Secondary Master PIO	Auto	
IDE Secondary Master PIO	Auto	
IDE Secondary Master PIO	Auto	
IDE Secondary Master PIO	Auto	
** On-Chip Serial ATA Setting **		
SATA Mode	IDE	
On-Chip Serial ATA	Auto	
Serial ATA Port0	Primary Master	
Serial ATA Port1	Primary Master	
IDE HDD Block Mode	Enabled	
↑↓→← : Move Enter: Select +/-/PU/PD: Value F10: Save ESC: Exit F1: General Help F5: Previous Values F6: Fail-Safe Defaults F7: Optimized Defaults		

**CMOS Setup Utility-Copyright © 1984-2001 Award Software
On board Device**

USB Controller	Enable	
USB 2.0 Controller	Enabled	Menu Level ►
USB Keyboard Support	Disabled	
USB Mouse Support	Disabled	
AC97 Audio	Auto	
Hance Rapid Watchdog	0	

↑↓→← : Move Enter: Select +/-/PU/PD: Value F10: Save ESC: Exit F1: General Help
F5: Previous Values F6: Fail-Safe Defaults F7: Optimized Defaults

**BIOS Setup Utility-Copyright © 1984-2001 Award Software
Super IO Device**

Onboard FDC Controller	Enabled	
Onboard Serial Port 1	3F8/IRQ4	Menu Level ►
Onboard Serial Port 1	2F8/IRQ3	
UART Mode Select	Normal	
Red, TxD Active	Hi,Lo	
IR Transmission Delay	Enabled	
UR2 Duplex Mode	Half	
Use IR Pins	IR-Rx2Tx2	
Onboard Parallel Port	378/IRQ7	
Parallel Port Mode	SPP	
EPP Mode Select	EPP1.7	
ECP Mode Use DMA	3	
ICH Serial Port 1	3E8	
ICH Serial Port 1 Use IRQ	IRQ10	
ICH Serial Port 2	2E8	
ICH Serial Port 2 Use IRQ	IRQ11	
PWRON after power fail	OFF	

↑↓→← : Move Enter: Select +/-/PU/PD: Value F10: Save ESC: Exit F1: General Help
F5: Previous Values F6: Fail-Safe Defaults F7: Optimized Defaults

● **IDE Primary/Secondary Master/Slave PIO**

The four IDE PIO (Programmed Input/Output) fields let you set a PIO mode (0-4) for each of the four IDE devices that the onboard IDE interface supports. Modes 0 through 4 provide successively increased performance. In Auto mode, the system automatically determines the best mode for each device. The options available are Auto, Mode 0, Mode 1, Mode 2, Mode 3, and Mode 4.

● **IDE Primary/Secondary Master/Slave UDMA**

Ultra DMA 66/100 implementation is possible only if your IDE hard drive supports it and the operating environment includes a DMA driver (Windows 95 OSR2 or a third-party IDE bus master driver). If your hard drive and your system software support Ultra DMA 33/66/100, select Auto to enable BIOS support. The options available are Auto, Mode 0, Mode 1, and Mode 2.

- **On-Chip Primary/Secondary PCI IDE**

The integrated peripheral controller contains an IDE interface with support for two IDE channels. Select Enabled to activate each channel separately. The default value is “Enabled”.

NOTE: *Choosing Disabled for these options will automatically remove the IDE Primary Master/Slave PIO and/or IDE Secondary Master/Slave PIO items on the menu.*

- **USB Keyboard Support**

Select *Enabled* if your system contains a Universal Serial Bus (USB) controller and you have a USB keyboard.

- **Init Display First**

This item allows you to decide to active whether PCI Slot or AGP first. The options available are PCI Slot, AGP.

- **IDE HDD Block Mode**

This field allows your hard disk controller to use the fast block mode to transfer data to and from your hard disk drive.

- **POWER ON Function**

This option allows users to select the type of power ON sequence for the system to follow. The default value is "Button-Only".

BUTTON-ONLY	Follows the conventional way of turning OFF system power (via power button).
Password	Upon selecting this option, the KB POWER ON Password line appears. Press <Enter> and you'll be prompted to enter and confirm a password of your choice. After setting the password, succeeding attempts to power ON the system will result to null. For system to activate, user must input the password via keyboard then press <Enter>.
Hot KEY	This option is very similar with that of Password. Hot-key combinations range from Ctrl-F1 to Ctrl-F12. User may define this combination from the Hot key Power ON option.

- **Onboard FDC Controller**

Select Enabled if your system has a floppy disk controller (FDC) installed on the system board and you wish to use it. If you install and-in FDC or the system has no floppy drive, select Disabled in this field. The options available are Enabled, Disabled.

- **Onboard Serial Port 1/Port 2**

Select an address and corresponding interrupt for the first and second serial ports. The options available are 3F8/IRQ4, 2E8/IRQ3, 3E8/IRQ4, 2F8/IRQ3, Disabled, Auto.

- **UART2 Duplex Mode**

The second serial port offers these infrared interface modes:

- IrDA
- ASKIR IrDA-compliant serial infrared port
- Normal (default value)

NOTE: *The UART Mode Select will not appear on the menu once you disable the setting of Onboard Serial Port 2.*

When UART Mode Select is set as ASKIR or IrDA, the options RxD, TxD Active and IR Transmission delay will appear.

- **Parallel Port Mode**

Select an operating mode for the onboard parallel (printer) port. Select Normal unless your hardware and software require one of the other modes offered in this field. The options available are EPP1.9, ECP, SPP, ECPEPP1.7, and EPP1.7.

- **ECP Mode Use DMA**

Select a DMA channel for the parallel port for use during ECP mode.

4.9 Power Management Setup

The Power Management Setup allows you to save energy of your system effectively. It will shut down the hard disk and turn OFF video display after a period of inactivity.

CMOS Setup Utility-Copyright © 1984-2001 Award Software
Power Management Setup

ACPI function	Enabled	Item Help
ACPI Suspend Type	S1(POS)	
Power Management	Min Saving	
PM Control by APM	Yes	Menu Level ►
Video Off Method	V/H SYNC+Blank	
Video off After	Standby	
MODEM Use IRQ	3	
Suspend Mode	1 Hour	
HDD Power Down	15 Min	
Soft-Off by PWR-BTTN	Instant-Off	
CPU THRM-Throttling	50.0%	
Wake-up by PCI card	Enabled	
PowerOn by Ring	Enabled	
Wake UP On LAN	Enabled	
USB KB Wake-Up From S3	Disabled	
Resume by Alarm	Disabled	
Date (of Month) Alarm	0	
Time (hh:mm:ss) Alarm	0:0:0	
** Reload Global Timer Events **		
Primary IDE 0	Disabled	
Primary IDE 1	Disabled	
Secondary IDE 0	Disabled	
Secondary IDE 1	Disabled	
FDD,COM,LPT Port	Disabled	
PCI PIRQ[A-D]#	Disabled	
↑↓→← : Move Enter: Select +/-/PU/PD: Value F10: Save ESC: Exit F1: General Help F5: Previous Values F6: Fail-Safe Defaults F7: Optimized Defaults		

● **ACPI Function**

This item allows you to enable/disable the Advanced Configuration and Power Management (ACPI). The options available are Enabled, Disabled.

● **Power Management**

This option allows you to select the type (or degree) of power saving for Doze, Standby, and Suspend modes. The table below describes each power management mode:

Max Saving	Maximum power savings. Only Available for SL CPUs. Inactivity period is 1 minute in each mode.
User Define	Sets each mode individually. Select time-out periods in the PM Timers section, following.
Min Saving	Minimum power savings. Inactivity period is 1 hour in each mode (except the hard drive).
Disabled	Default value

● **PM Control by APM**

If Advanced Power Management (APM) is installed on your system, selecting Yes gives better power savings. The default value is "Yes".

No	System BIOS will ignore APM when power managing the system
Yes	System BIOS will wait for APM's prompt before it enters any PM mode (i.e., DOZE, STANDBY or SUSPEND). Note: If APM is installed or if there is a task running, even when the timer has timed out, the APM will not prompt the BIOS to put the system into any power saving mode!

NOTE: *If APM is not installed, this option has no effect.*

- **Video Off Method**

Determines the manner in which the monitor is blanked.

V/H SYNC+Blank	Turns OFF vertical and horizontal synchronization ports and writes blanks to the video buffer
DPMS	Select this option if your monitor supports the Display Power Management Signaling (DPMS) standard of the Video Electronics Standards Association (VESA). Use the software supplied for your video subsystem to select video power management values.
Blank Screen	System only writes blanks to the video buffer.

- **Video Off After**

As the system moves from lesser to greater power-saving modes, select the mode in which you want the monitor to blank off. The default value is “Standby”.

NA	System BIOS will never turn off the screen
Suspend	Screen off when system is in SUSPEND mode
Standby	Screen off when system is in STANDBY mode
Doze	Screen off when system is in DOZE mode

NOTE: *Green monitors detect the V/H SYNC signals to turn off its electron gun*

- **Modem Use IRQ**

3, 4, 5, 7, 9, 10, 11, NA	For external modem, 3 or 4 will be used for card type modem. It is up to card definition. Default is 3.
---------------------------------	---

- **Doze Mode**

After the selected period of system inactivity (1 minute to 1 hour), the CPU clock runs at slower speed while all other devices still operate at full speed. The default value is “Disabled”.

Disabled	System will never enter doze mode
1/2/4/6/8/10/20/30/ 40 Min/1 Hr	Defines the continuous idle time before the system entering DOZE mode.

-

● **Standby Mode**

After the selected period of system inactivity (1 minute to 1 hour), the fixed disk drive and the video shut off while all other devices still operate at full speed. The default value is “Disabled”.

Disabled	System will never enter STANDBY mode
1/2/4/6/8/10/20/30/40 Min/1 Hr	Defines the continuous idle time before the system entering STANDBY mode. If any item defined in (J) is enabled & active, STANDBY timer will be reloaded

● **Suspend Mode**

After the selected period of system inactivity (1 minute to 1 hour), all devices except the CPU shut off. The default value is “Disabled”.

Disabled	System will never enter SUSPEND mode
1/2/4/6/8/10/20/30/40 Min/1 Hr	Defines the continuous idle time before the system entering SUSPEND mode. If any item defined in (J) is enabled & active, SUSPEND timer will be reloaded

● **HDD Power Down**

After the selected period of drive inactivity (1 to 15 minutes), the hard disk drive powers down while all other devices remain active. The default value is “Disabled”.

Disabled	HDD's motor will not power OFF.
1/2/3/4/5/6/7/8/9/10/11/12/13/14/15 Min	Defines the continuous HDD idle time before the HDD enters power saving mode (motor OFF)

● **Throttle Duty Cycle**

When the system enters Doze mode, the CPU clock runs only part of the time. You may select the percent of time that the clock runs. The default value is “62.5%”.

● **VGA Active Monitor**

When Enabled, any video activity restarts the global timer for Standby mode. The default value is “Enabled”.

- **Soft-Off by PWR-BTTN**

This option only works with systems using an ATX power supply. It also allows the user to define which type of soft power OFF sequence the system will follow. The default value is “*Instant-Off*”.

Instant-Off	This option follows the conventional manner systems perform when power is turned OFF. Instant-Off is a soft power OFF sequence requiring only the switching of the power supply button to OFF
Delay 4 Sec.	Upon turning OFF system from the power switch, this option will delay the complete system power OFF sequence by approximately 4 seconds. Within this delay period, system will temporarily enter into Suspend Mode enabling you to restart the system at once.

- **Power On by Ring**

This option allows the system to resume or wake up upon detecting any ring signals coming from an installed modem. The default value is “*Enabled*”.

- **IRQ 8 Break Suspend**

You can turn on or off monitoring of IRQ8 (the Real Time Clock) so it does not awaken the system from Suspend mode. The default value is “*Disabled*”.

- **Reload Global Timer Events**

When *Enabled*, an event occurring on each device listed below restarts the global time for Standby mode.

4.10 PnP/PCI Configuration Setup

This section describes configuring the PCI bus system. PCI, or Personal Computer Interconnect, is a system which allows I/O devices to operate at speeds nearing the speed the CPU itself uses when communicating with its own special components. This section covers some very technical items and it is strongly recommended that only experienced users should make any changes to the default settings.

**CMOS Setup Utility-Copyright © 1984-2001 Award Software
PnP/PCI Configurations**

Reset Configuration Data	Disabled	Item Help
Resources Controlled By ▶ IRQ Resources	Auto (ESCD) Press Enter	Menu Level ▶ Select Yes if you are using a Plug and play Mini ITXble operating system select No if you need the BIOS to configure non-boot devices
PCI/VGA Palette Snoop	Disabled	
↑↓→← : Move Enter: Select +/-PU/PD: Value F10: Save ESC: Exit F1: General Help F5: Previous Values F6: Fail-Safe Defaults F7: Optimized Defaults		

- **PNP OS Installed**
Select Yes if the system operating environment is Plug-and-Play aware (e.g., Windows 95). The default value is "No".
- **Reset Configuration Data**
Normally, you leave this field Disabled. Select Enabled to reset Extended System Configuration Data (ESCD) when you exit Setup or if you have installed a new add-on and the system reconfiguration has caused such a serious conflict that the operating system can not boot. The options available are Enabled and Disabled.

- **Resources Controlled By**

The Award Plug and Play BIOS can automatically configure all the boot and Plug and Play-compatible devices. If you select Auto, all the interrupt request (IRQ), DMA assignment, and Used DMA fields disappear, as the BIOS automatically assigns them. The default value is “Manual”.

- **IRQ Resources**

When resources are controlled manually, assign each system interrupt as one of the following types, depending on the type of device using the interrupt:

1. Legacy ISA Devices compliant with the original PC AT bus specification, requiring a specific interrupt (such as IRQ4 for serial port 1).
2. PCI/ISA PnP Devices compliant with the Plug and Play standard, whether designed for PCI or ISA bus architecture.

The default value is “*PCI/ISA PnP*”.

- **DMA Resources**

When resources are controlled manually, assign each system DMA channel as one of the following types, depending on the type of device using the interrupt:

1. Legacy ISA Devices compliant with the original PC AT bus specification, requiring a specific DMA channel.
2. PCI/ISA PnP Devices compliant with the Plug and Play standard, whether designed for PCI or ISA bus architecture.

The default value is “*PCI/ISA PnP*”.

- **Memory Resources**

This sub menu can let you control the memory resource.

- **PCI /VGA Palette Snoop**

Some non-standard VGA display cards may not show colors properly. This field allows you to set whether MPEG ISA/VESA VGA Cards can work with PCI/VGA or not. When enabled, a PCI/VGA can work with a MPEG ISA/VESA VGA card. When disabled, a PCI/VGA cannot work with a MPEG ISA/VESA Card.

- **Assign IRQ For USB/VGA**

Enable/Disable to assign IRQ for USB/VGA.

4.11 PC Health Status

This option configures the PCI bus system. All PCI bus systems on the system use INT#, thus all installed PCI cards must be set to this value.

CMOS Setup Utility-Copyright © 1984-2001 Award Software
PC Health Status

CPU Warning Temperature	Disabled	Item Help
Current GMCH Temperature		Menu Level ►
Current CPU Temp.		
Current System Temp.		
Current FAN1 Speed		
Current FAN2 Speed		
Vcore		
VTT		
+3.3V		
+5V		
+12V		
-12V		
-5V		
VBAT (V)		
5VSB (V)		
Shutdown Temperature	Disabled	
↑↓→← : Move Enter: Select +/-PU/PD: Value F10: Save ESC: Exit F1: General Help F5: Previous Values F6: Fail-Safe Defaults F7: Optimized Defaults		

- **Current CPU Temperature**
 These read-only fields reflect the functions of the hardware thermal sensor that monitors the chip blocks and system temperatures to ensure the system is stable.
- **Current FAN1/FAN2 Speed**
 These optional and read-only fields show the current speeds in RPM (revolution per minute) for the CPU fan and chassis fan as monitored by the hardware monitoring IC.

4.12 Frequency/Voltage Control

This option configures the PCI bus system. All PCI bus systems on the system use INT#, thus all installed PCI cards must be set to this value.

CMOS Setup Utility-Copyright © 1984-2001 Award Software Frequency/Voltage Control

Auto Detect DIMM/PCI Clk	Enabled	Item Help
Spread Spectrum	[Disabled]	Menu Level ▶
↑↓→← : Move Enter: Select +/-/PU/PD: Value F10: Save ESC: Exit F1: General Help F5: Previous Values F6: Fail-Safe Defaults F7: Optimized Defaults		

- **Auto Detect DIMM/PCI Clk**
This item automatically detects the clock speeds of the system memory installed as well as the PCI interface. The options available are Enabled and Disabled. The default setting is **Enabled**.
- **Speed Spectrum**
This item directly relates to the EMI performance of the whole system. When enabled, all system clocks run at slower speeds thereby decreasing the electromagnetic interference to the surrounding environment. Disabling this item improves the system performance but simultaneously increase the EMI. The default setting is **Disabled**.

4.13 Load Fail-Safe Defaults

This option allows you to load the troubleshooting default values permanently stored in the BIOS ROM. These default settings are non-optimal and disable all high-performance features.

CMOS Setup Utility-Copyright © Award Software

▶ Standard CMOS Features	▶ Frequency/Voltage Control
▶ Advanced BIOS Features	Load Fail-Safe Defaults
▶ Advanced Chipset Features	Load Optimized Defaults
▶ Integrated Peripherals	Set Supervisor Password
▶ Power Management	
▶ PnP/PCI Configurations	
▶ PC Health Status	Exit Without Saving
Esc : Quit	↑ ↓ → ← : Select Item
F10 : Save & Exit Setup	
Load Fail-Safe Defaults	

To load BIOS defaults value to CMOS SRAM, enter “Y”. If not, enter “N”.

4.14 Load Optimized Defaults

This option allows you to load the default values to your system configuration. These default settings are optimal and enable all high performance features.

CMOS Setup Utility-Copyright © Award Software

▶ Standard CMOS Features	▶ Frequency/Voltage Control
▶ Advanced BIOS Features	Load Fail-Safe Defaults
▶ Advanced Chipset Features	Load Optimized Defaults
▶ Integrated Peripherals	Set Supervisor Password
▶ Power Man	Load Optimized Defaults (Y/N)? N
▶ PnP/PCI Co	
▶ PC Health Status	Exit Without Saving
Esc : Quit	↑ ↓ → ← : Select Item
F10 : Save & Exit Setup	
Load Optimized Defaults	

To load SETUP defaults value to CMOS SRAM, enter “Y”. If not, enter “N”.

4.15 Set Supervisor/User Password

You can set either supervisor or user password, or both of them. The differences between are:

1. **Supervisor password:** can enter and change the options of the setup menus.
2. **User password:** just can enter but do not have the right to change the options of the setup menus.

When you select this function, the following message will appear at the center of the screen to assist you in creating a password.

ENTER PASSWORD:

Type the password with eight characters at most, and press <Enter>. The password typed will now clear any previously entered password from CMOS memory. You will be asked to confirm the password. Type the password again and press <Enter>. You may also press <Esc> to abort the selection and not enter a password.

To disable password, just press <Enter> when you are prompted to enter password. A message will confirm the password being disabled. Once the password is disabled, the system will boot and you can enter Setup freely.

PASSWORD DISABLED.

When a password is enabled, you have to type it every time you enter Setup. This prevents any unauthorized person from changing your system configuration.

Additionally when a password is enabled, you can also require the BIOS to request a password every time the system reboots. This would prevent unauthorized use of your computer.

You determine when the password is required within the BIOS Features Setup Menu and its Security option. If the Security option is set to "System", the password is required during boot up and entry into Setup. If set as "Setup", prompting will only occur prior to entering Setup.

4.16 Save & Exit Setup

This allows you to determine whether or not to accept the modifications. Typing “Y” quits the setup utility and saves all changes into the CMOS memory. Typing “N” brings you back to Setup utility.

CMOS Setup Utility-Copyright © Award Software	
▶ Standard CMOS Features	▶ Frequency/Voltage Control
▶ Advanced BIOS Features	Load Fail-Safe Defaults
▶ Advanced Chipset Features	Load Optimized Defaults
▶ Integrated Peripherals	Set Supervisor Password
▶ Power Man	SAVE to CMOS and EXIT (Y/N)? Y
▶ PnP/PCI Con	
▶ PC Health Status	Exit Without Saving
Esc : Quit	↑ ↓ → ← : Select Item
F10 : Save & Exit Setup	
Save Data to CMOS	

4.17 Exit Without Saving

Select this option to exit the Setup utility without saving the changes you have made in this session. Typing “Y” will quit the Setup utility without saving the modifications. Typing “N” will return you to Setup utility.

CMOS Setup Utility-Copyright © Award Software	
▶ Standard CMOS Features	▶ Frequency/Voltage Control
▶ Advanced BIOS Features	Load Fail-Safe Defaults
▶ Advanced Chipset Features	Load Optimized Defaults
▶ Integrated Peripherals	Set Supervisor Password
▶ Power Man	Quit Without Saving (Y/N)? N
▶ PnP/PCI Con	
▶ PC Health Status	Exit Without Saving
Esc : Quit	↑ ↓ → ← : Select Item
F10 : Save & Exit Setup	
Abandon all Data's	

This page does not contain any information.

Appendix A

Watch Dog Timer

Watchdog Timer Setting

The watchdog timer makes the system auto-reset while it stops to work for a period. The integrated watchdog timer can be setup as system reset mode by program.

- Timeout Value Range
 - 1 to 255
 - Second
- Program Sample

Watchdog timer setup as system reset with 5 second of timeout

2E, 87	
2E, 87	
2E, 07	
2F, 00	Logical Device 0
2E, 2D	Set WDT Funtion Enable
2F, 20	
2E, 07	
2F, 08	Logical Device 8
2E, 30	Activate
2F, 01	
2E, F5	Set Second
2F, N	N = 00 or 08
2E, F6	Set Value

[Watch Dog Timer](#)

2F, M	M = 00 ~ FF
--------------	-------------

Chapter 2 Using the Watchdog Function

Start	
↓	
Un-Lock WDT	:O 2E 87 ; Un-lock super I/O O 2E 87 ; Un-lock super I/O
↓	
Select Logic device	: O 2E 07 O 2F 00
Set WDT Function	: O 2E 2D O 2F 20
Select Logic device	: O 2E 07 O 2F 08
Set Second or Minute	: O 2E F5 O 2F N N=00 or 04(See below table)
↓	
Set base timer	:O 2E F6 O 2F M=00,01,02,...FF(Hex) ,Value=0 to 255
↓	
Activate WDT	:O 2E 30 O 2F 01
↓	
WDT counting	
↓	
re-set timer	:O 2E F6 O 2F M ; M=00,01,02,...FF(See below table)
↓	
IF No re-set timer	:WDT time-out, generate RESET
IF to disable WDT	:O 2E 30 O 2F 00 ; Can be disable at any time

M	N=0	M	N=0	M	N=0	M	N=8
02	1sec	33	50sec	B5	180sec	11	992sec
03	2sec	38	55sec	BF	190sec	22	2012sec
04	3sec	3D	60sec	C9	200sec	33	3032sec
05	4sec	42	65sec	D3	210sec	43	3992sec
06	5sec	47	70sec	DD	220sec	54	5012sec
07	6sec	4C	75sec	E7	230sec	65	6032sec
08	7sec	51	80sec	F1	240sec	75	6992sec
09	8sec	56	85sec	FB	250sec	86	8012sec
M	N=0	M	N=0	M	N=8	M	N=8
0B	10sec	65	100sec	05	272sec	97	9032sec
10	15sec	6F	110sec	06	332sec	A7	9992sec
15	20sec	79	120sec	07	392sec	B8	11012sec
1A	25sec	83	130sec	08	452sec	C9	12032sec
1F	30sec	8D	140sec	09	512sec	D9	12992sec
24	35sec	97	150sec	0A	572sec	EA	14012sec
29	40sec	A1	160sec	0B	632sec	FB	15032sec
2E	45sec	AB	170sec	0C	692sec		

[Watch Dog Timer](#)